



Model: **XPB700WDR**  
700 TVL Dynamic Night View,  
Super WDR & Smart DNR Camera

## Before you begin

- Please unpack the box carefully and identify that all the parts are present.

The camera is suitable for indoor or outdoor use. Please bear in mind the following points when choosing a mounting position.

- The camera must be positioned so that it will not point directly into the sun (sunrise and sunset) or any bright light, as this may cause damage to the camera.
- Do not cut the camera cables, this will void the warranty.
- Make sure you use only the recommended power supply. Damage caused to the camera by incorrect voltage or wiring is not covered by the warranty.

Model:  
**XPB700WDR**

B/W 700TVL Colour 580TVL,  
Dynamic Night View, Super WDR,  
Smart DNR for Disk Saving & Varifocal

Thank you for purchasing this Xvision camera. Before operating this product, please read this instruction manual carefully.

## 1. Safety Precautions



### CAUTION

RISK OF ELECTRIC SHOCK.  
DO NOT OPEN!



CAUTION: TO REDUCE THE RISK OF ELECTRIC SHOCK, DO NOT OPEN COVERS UNLESS MAKING LENS ADJUSTMENTS. NO USER SERVICEABLE PARTS INSIDE. REFER SERVICING TO QUALIFIED SERVICE PERSONNEL.

- When in use please do not touch the camera body as it can get very hot.
- When installing the camera, please avoid pointing it directly at paper or flammable materials.
- Please avoid all direct contact with the tempered glass cover to avoid contamination. If you need to clean the cover use cotton wool balls dipped in alcohol or glass wipes.

## 2. Product Description

The XPB700WDR camera is designed for high risk applications. It offers very high resolution images of 580 TVL in Colour mode and 700 TVL in B/W mode, with a low lux sensitivity of 0.0003 lux. It features Dynamic Night View, Super WDR, Smart DNR for disk saving and an Auto Iris Varifocal Lens. It is designed for internal or external use and can be wall mounted.

### 3. Features

- Sony 1/3" CCD Image Sensor, Samsung DSP Chip & Xvision X4 DSP Software
- 5.0 to 50.0mm Auto Iris Varifocal lens for 6° to 49° viewing angle for super sharp images and easy selection of the optimum viewing angle during installation.
- Dynamic Night View technology provides clear images without the need for IR LEDs down to 0.0003 lux, this is achieved by using a Digital Slow Shutter, please note due to the way in which this technology works, whilst it is in operation the frames per second will reduce. The darker the scene the lower the frames per second, resulting in a non real time image.
- Super WDR technology provides a clear overall picture even when strong backlight or bright spots are present.
- Smart DNR (Digital Noise Reduction) reduces the noise on the image when viewing in low lux environments (like at night), this reduces the size of the image when being recorded by a DVR, resulting in a saving of disk space.

3

### 4. Contents

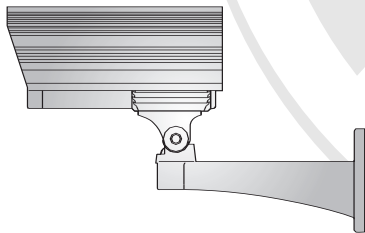

XPB700WDR Camera

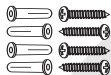

4x Fixing Screws  
4x Wall Plugs



Hex Wrench

## 5. Product Assembly

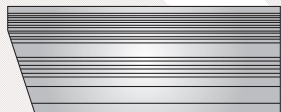

Sun/Rain Shield

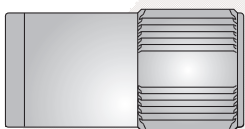

Camera Body

When attaching the bracket to the camera be careful not to damage the cable.

4

Bracket Securing Bolt

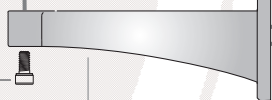

Camera Bracket



Power Cable



Video Cable

Figure 1

## 6. Installation

1. Make a hole in the wall approximately 30mm wide x 40mm deep.
2. Drill 4 holes and insert the wall plugs.
3. Feed the cables into the wall before fixing the camera using the 4 fixing screws

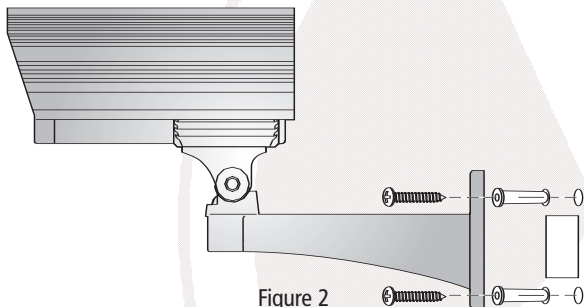
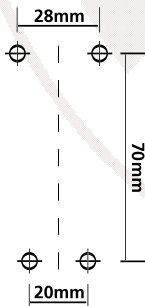

Figure 2

Fixing Holes Guide-  
Not shown actual size



## 7. Lens Adjustment

The XPB700WDR is fitted with a Varifocal lens. You can make adjustments to both the Zoom and Focal Length by following these easy steps:

STEP 1: Carefully unscrew the camera housing and pull the casing away.

STEP 2: Connect the Video Output to the monitor or other video device through a 75 Ohms type coaxial cable.

STEP 3: Once the picture appears on the monitor, make the Zoom Adjustment by rotating the long screw (NEAR-Anti-clockwise, FAR Clockwise) until you get the desired view. Next make the Focal Adjustment by rotating the long screw (TELE-Anticlockwise, WIDE Clockwise) until you get the desired view (as shown in Figure 3). (If the long screw does not move turn it Anti-clockwise to unscrew it, this will loosen it and allow you to make the adjustment, after adjustment tighten both screws by turning Clockwise, see Figure 4).

6

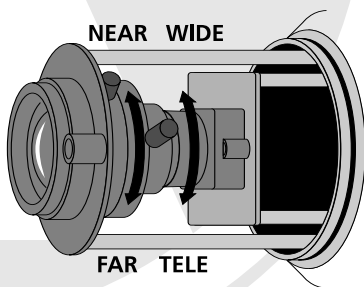

Figure 3

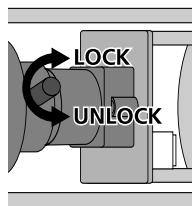
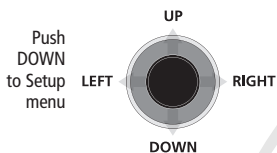

Figure 4

## 8. Camera OSD Control



Press this Control	Action
UP, DOWN	Select a new item
LEFT, RIGHT	Select a menu item
SETUP (MENU)	Access a sub menu

## 9. OSD Menu Structure

### SET UP MENU

LENS Option	● DC	● VIDEO	● MANUAL
EXPOSURE	● SHUTTER	● AGC	● SENS-UP ● RETURN
WHITE BALANCE	● ATW	● MANUAL	● AWC>SET
	● OUTDOOR	● INDOOR	
BACKLIGHT	● OFF	● WDR	● BLC
DNR	● ON	● OFF	
DAY/NIGHT	● COLOUR	● B/W	● AUTO ● RETURN
IMAGE ADJUSTMENT	● FREEZE	● V-REV	● H-REV
	● D-ZOOM	● SHARPNESS	● RETURN
SPECIAL	● CAM TITLE	● SYNC	● MOTION
	● PRIVACY	● DIS	● COMM ADJ
	● LANGUAGE	● RESET	● RETURN
EXIT			

## 10. SETUP Menu Functions

### 1 LENS

<Option: DC / VIDEO / MANUAL>

Selects lens type and controls screen brightness.

### 2 EXPOSURE

<Option: SHUTTER / AGC / SENS-UP / RETURN>

Selects a desired mode.

SHUTTER : Selects either auto or manual shutter.

AGC: The higher the gain level, the brighter the screen -but the higher the noise.

SENS-UP (Dynamic Night View): When it is night or dark, the camera automatically detects the light level and maintains a clear picture if this mode is activated.

8

### 3 WHITE BALANCE

<Option: ATW / MANUAL / AWC->SET / OUTDOOR / INDOOR>

Adjusts the screen colour.

ATW : Selects this when the colour temp. is between 1800° ~ 10500°K.

INDOOR: Selects this when the colour temp. is between 4500°K ~ 8500°K.

OUTDOOR: Selects this when the colour temp. is between 1800°K ~ 10500°K. (sodium light inclusion)

AWC->SET: To find the optimal setting for the current luminance environment, set the point the camera towards white paper and press the SET button.

MANUAL: Fine-tune White Balance manually.

## 10. SETUP Menu Functions

(continued)

### 4 BACK LIGHT

<Option: OFF / WDR / BLC>

Selects a desired mode.

OFF: Deactivates the WDR function.

WDR (Super WDR): When there are both bright and dark areas at the same time, this mode makes both areas distinctive.

BLC: Enables a user to directly select a desired area from a picture, and to view the area more clearly.

### 5 DNR (Smart DNR)

<Option: ON / OFF>

Reduces the background noise.

ON: Activates DNR so that noise is reduced.

OFF: Deactivates DNR. Noise is not reduced.

9

### 6 DAY/NIGHT

<Option: COLOUR / B/W / AUTO / RETURN>

Displays pictures in color or black and white.

COLOUR: The picture is always displayed in color.

B/W: The picture is always displayed in black and white.

AUTO : The mode is switched to COLOUR in a normal environment, but switches to B/W mode in a low luminance environment.

### 7 IMAGE ADJ.

<Option: FREEZE / V-REV / H-REV / D-ZOOM / SHARPNESS / RETURN>

## 10. SETUP Menu Functions

(continued)

**FREEZE:** You can view still or moving pictures.

**V-REV:** You can flip the picture vertically on the screen.

**H-REV:** You can flip the picture horizontally on the screen.

**D-ZOOM:** You can use a digital zoom of x1~x10.

**SHARPNESS:** As you increase this value, the picture outline becomes stronger and clearer. Adjust this value appropriately depending on the sharpness of the picture.

### 8 SPECIAL

<Option: CAMTITLE / SYNC / MOTION DET / PRIVACY / DIS / COMM  
ADJ / LANGUAGE / RESET / RETURN>

**CAMTITLE:** Enters a title, the title will appear on the monitor.

**SYNC:** In areas where the supply is at 60Hz, you can synchronize the output phase of multiple cameras using the power synchronization function (Line-Lock) without using a synchronization signal generator.

- INT: Internal Synchronization Type
- L/L: Power Synchronization Type, Line-Lock

**MOTION DET:** In a large multi camera system it is easy to miss small movements, specially when viewing over 9 cameras on one monitor, the Motion Detection function will display an On Screen Overlay Message on the cameras output alerting you of movement being detected.

- SENSITIVITY: You can select up to 8MD areas.

When number is high, motion detection sensitivity is increased to recognise even small movement.

## 10. SETUP Menu Functions

(continued)

- AREA MODE: Determines whether to use the MD area selected in SENSITIVITY.
- SEL POS: Determines which of the 4 vertices of each MD area is to be used.
- YPOS: Determines the coordinate of the vertical axis for SEL POS.
- XPOS: Determines the coordinate of the horizontal axis for SEL POS.
- FILL->SET: Fills in a selected MD area.

PRIVACY: Hide an area you want to hide on the screen.

DIS: This function lessens any picture movement due to external factors such as wind.

COMM ADJ.(Communication Adjustment): This function sets up the camera communication status when controlling the camera through an external control device.

- CAM ID: Determines the camera's ID No. (0~25)
- BAUD RATE: Selects baud rate.
- UART MODE: You can select NONE, EVEN or ODD for the parity bits.
- RET PKT: Determines whether to send a command back to the controller device when a communication control command is sent to the camera.
- DISP CAM ID: Display camera title on the screen.

LANGUAGE: Selects the menu language.

RESET: Resets the camera settings to the factory defaults.

## 10. SETUP Menu Functions (continued)

### 9 EXIT

Press the SET button in the EXIT menu to save the current settings and exit the SET menu.

## 11. Specifications

<b>Model:</b>	<b>XPB700WDR</b>
Picture Type:	Day/Night (B/W & Colour)
Image Sensor:	Sony 1/3" CCD
DSP:	Samsung DSP Chip & Xvision X4 DSP Software
Resolution:	700 TVL B/W 580TVL Colour
Lens Viewing Angle:	6 to 49°
Infra Red Nightvision:	Not sensitive to IR
Minimum Illumination:	0.0003 Lux
Audio:	No
Operating Voltage:	12V DC 150mA
Suggested Power Supply:	12V DC 300mA Regulated
Mounting:	Wall/Ceiling
Weatherproofing:	Yes
Dimensions (ØxD):	85mm x 130mm

## NOTES

## NOTES

**TECHNICAL SUPPORT:**

For Technical Support for any Xvision product please contact your local distributor.

**LIMITED WARRANTY:**

This product is supplied with a limited 3 Year warranty. The Warranty excludes products that have been misused, (including accidental damage) and damage caused by normal wear and tear. In the unlikely event that you encounter a problem with this product, it should be returned to the place of purchase.

16



Manufactured exclusively for:  
**Xvision (Europe) Group,**  
Head Office: London, U.K.  
Email: [info@x-vision.co.uk](mailto:info@x-vision.co.uk)  
Web: [www.x-vision.co.uk](http://www.x-vision.co.uk)